

# USER MANUAL

**1~20K Online UPS**



# Introduction

---

Thanks for choosing Online UPS products!

Online UPS double conversion online UPS powered by DSP digital control technology and high frequency PWM Inverter technology, output clean and stable AC mains supply, provides comprehensive protection to mission critical equipment, such as computer, communication equipment, medical equipment etc. from loss of data or even hardware damage by power blackout or other kind of power quality issues.

This manual introduce Online UPS functions and features, guidance to installation operation, maintenance and transportation information.

Please read this manual carefully and thoroughly before operation the UPS. The manual is offered when you purchase our product.

# Content

---

Chapter 1 Safety Instruction .....	4
Chapter 2 Product Introduction .....	5
2.1 Product introduction .....	5
2.2 Product Model List .....	5
2.3 UPS Outlook .....	6
Chapter 3 Installation .....	11
3.1 Product inspection .....	11
3.2 Installation .....	11
3.3 Wiring .....	11
Chapter 4 Panel & Operation Guide .....	19
4.1 Front panel .....	19
4.2 UPS Working Mode .....	21
4.3 Operation .....	22
Chapter 5 Maintenance .....	24
5.1 Routine Maintain .....	24
5.2 Battery Maintain .....	24
Chapter 6 Trouble shooting .....	25
6.1 LCD Warning and Fault Code .....	25
Chapter 7 Specification .....	26
7.1 1 phase input model Specification .....	26
7.2 3phases input model Specification .....	27
7.2 Mechanical .....	28
7.3 Environmental .....	28
7.4 EMC & Safety Regulation .....	29
Warranty .....	29

# Chapter 1 Safety Instruction

---

This manual contains important instructions that you should follow during installation and maintenance of the UPS and batteries. Please read all instructions before operating the equipment and save this manual for future reference.

Strictly follow the Safety instruction for equipment installation, operation and maintenance, inappropriate operation may cause injury to personnel and equipment. Manufacturer assume no responsibility for violation of operation.

## **Danger**

- This UPS contains LETHAL VOLTAGES. All repairs and service should be performed by AUTHORIZED SERVICE PERSONNEL ONLY. There are NO USER SERVICEABLE PARTS inside the UPS.
- CUT OFF all power supply before any installation and manipulation of power wiring.
- Reverse connection polarity, short-circuit of battery terminal may cause harmful high current, or even fire, make sure proper connect battery.
- Cable with sufficient current rating should be used for wiring, secure fixation and proper insulation are all required to avoid fire accident cause by wired overheat or short-circuit.

## **Warning**

- This UPS contains its own energy source (batteries). The UPS output may carry live voltage even when the UPS is not connected to an AC supply.
- To reduce the risk of fire or electric shock, install this UPS in a temperature and humidity controlled, indoor environment, free of conductive contaminants. Ambient temperature must not exceed 40°C (104°F). Do not operate near water or excessive humidity (90% maximum).
- To reduce the risk of fire, connect only to a circuit provided with branch circuit over-current protection . Output over current protection and disconnect switch must be provided by others.
- To comply with international standards and wiring regulations, the sum of the leakage current of the UPS and the total equipment connected to the output of this UPS must not have an earth leakage current greater than 3.5 milliamperes.
- If installing optional rack-mount Battery Pack, install the Battery Pack directly below the UPS so that all wiring between the cabinets is installed behind the front covers and is inaccessible to users.

## **Caution**

- Batteries can present a risk of electrical shock or burn from high short-circuit current. Observe proper precautions. Servicing should be performed by qualified service personnel knowledge of batteries and required precautions. Keep unauthorized personnel away from batteries.
- Proper disposal of batteries is required. Refer to your local codes for disposal requirements.
- Never dispose of batteries in a fire. Batteries may explode when exposed to flame.
- In the event of fire occurring in the vicinity, please use dry powder fire extinguishers. The use of liquid fire extinguishing agents may cause electric shock.

# Chapter 2 Product Introduction

## 2.1 Product introduction

Online UPS single phase Uninterruptible Power Supply (UPS) is a new generation product incorporating advanced digital control technology and double-conversion power topology, the product capable of working with ultra wide range of electric input with high efficiency and reliability, protect mission critical equipment with clean, safe, high-quality AC power supply. The Online UPS user friendly interface make it easy to use, the small dimension for saving valuable installation space, perfectly meet infrastructure needs in areas of IT, finance, traffic control, manufacturing industry, education and government etc.

## 2.2 Product Model List

Online UPS model naming rule shown below.

[n] K [R] [L]

n indicates capacity of UPS 1,2,3,6,10,15,20kVA product for this manual.

[R] With R indicates Rack mounted model, without R is Tower form factor.

[L] With L indicates Long Backup Time model, UPS can connect with external batteries for extra long backup time. And product model name without L indicates standard backup time model with internal battery.

Product type and Capacity	Model Name	Remark	
Standard Model	1KVA	T1K(R)	With a 1A internal charger and 2 Pcs batteries
	2KVA	T2K(R)	With a 1A internal charger and 4 Pcs batteries
	3KVA	T3K(R)	With a 1A internal charger and 4 or 6 Pcs batteries
	6KVA	T6K(R)	With a 1A internal charger and 16 batteries
	10KVA	T10K(R)	With a 1A internal charger and 16 batteries
	15KVA	T15K(R)-3P1	With a 1A internal charger and 32 batteries
	20KVA	T20K(R)-3P1	With a 1A internal charger and 32 batteries
Long Backup Time Model	1KVA	T1K(R)L	With a 4A internal charger and external battery
	2KVA	T2K(R)L	With a 4A internal charger and external battery
	3KVA	T3K(R)L	With a 4A internal charger and external battery
	6KVA	T6K(R)L	With a 4A internal charger and external battery
	10KVA	T10K(R)L	With a 4A internal charger and external battery
	15KVA	T10K(R)L-3P1	With a 4A internal charger and external battery
	15KVA	T15K(R)L-3P1	With a 4A internal charger and external battery
	20KVA	T20K(R)L-3P1	With a 4A internal charger and external battery

Note: For Rack Mount Product, there are models with or without internal battery, confirm on the product name plate or consult with distributor for best suitable to your application.

## 2.3 UPS Outlook

### 2.3.1 Front View

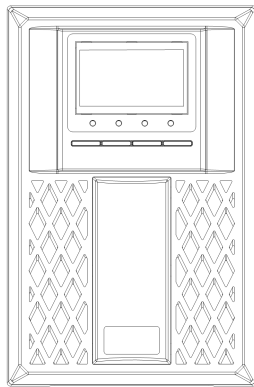

T1K(L)/ T2K(L)

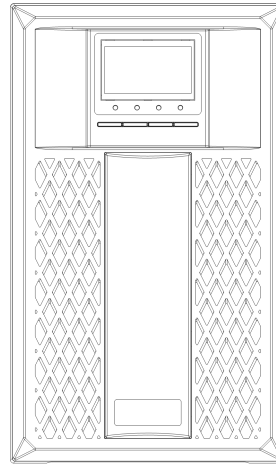

T3K(L)/ T6K(L)/ T10K(L)

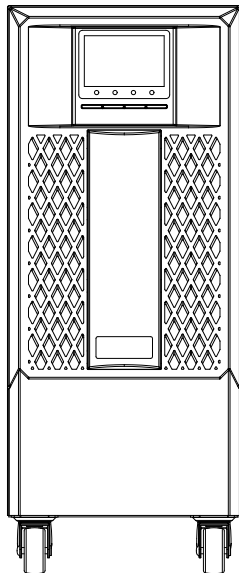

T10K

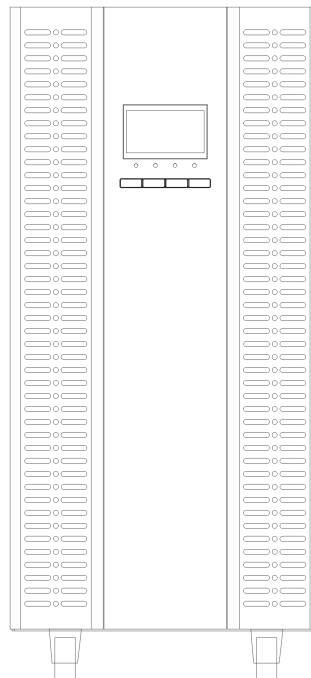

T15/T20KL

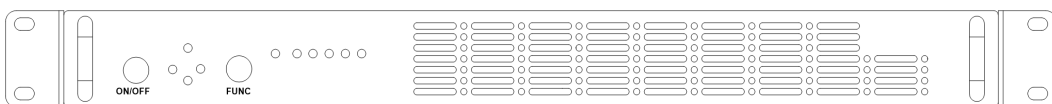

T1KR(L)-1U

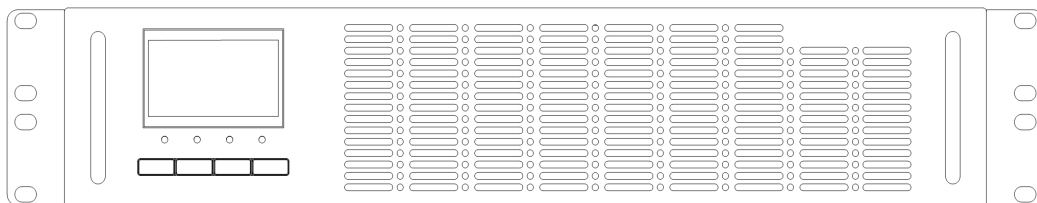

T1KR(L)/T2KR(L)/T3KR(L) /T6KR(L)/T10R(L) RACK UPS

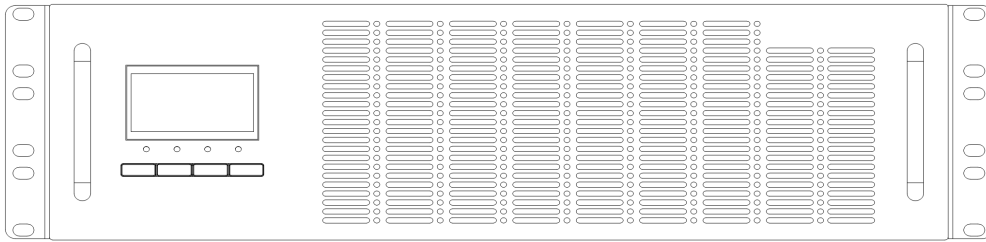

T10KRL-3P1 3U Rack UPS Front Panel

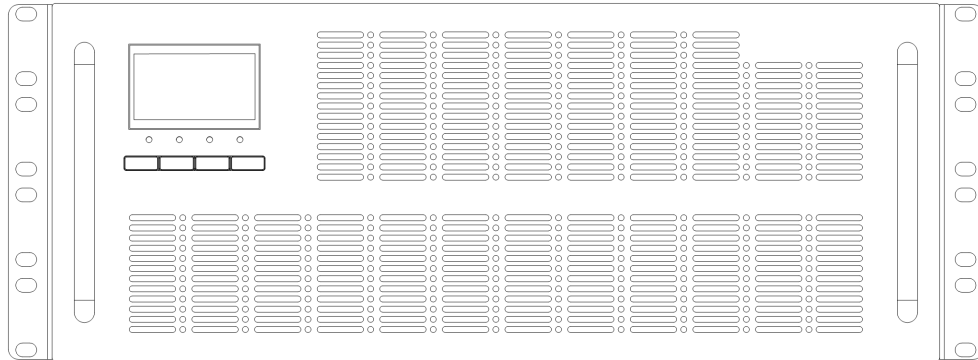

T15KRL/T20KRL-3P1 4U Rack UPS Front Panel

### 2.3.2 Rear View

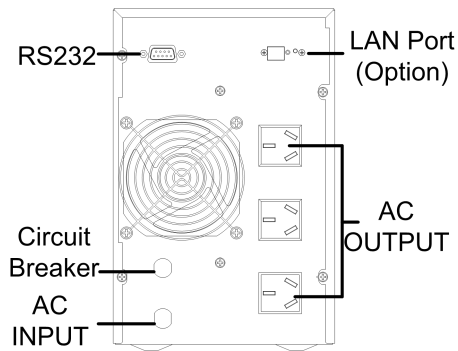

T1K(L)-HV Rear Panel

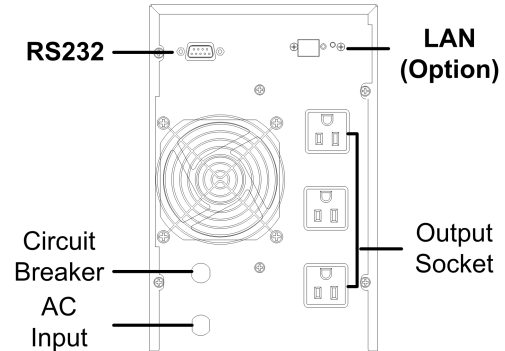

T1K-LV Rear Panel

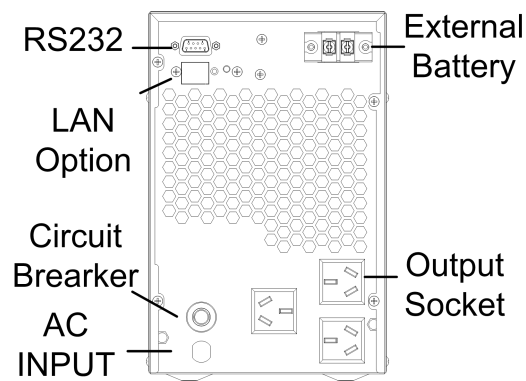

T1K/T2KL\_HV Rear Panel

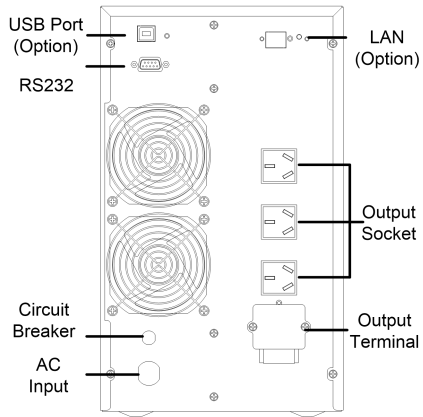

T3K\_HV Rear Panel

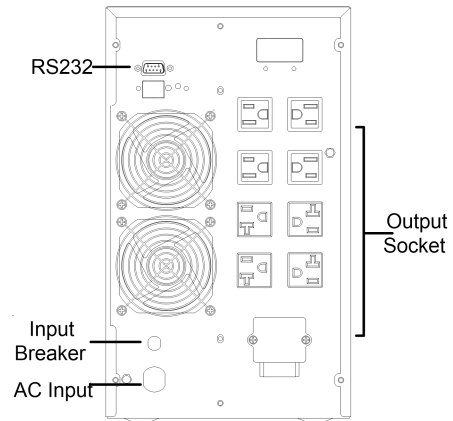

T3K(L)\_LV Rear Panel

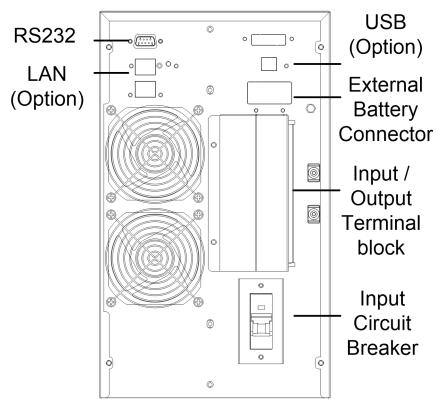

T6K(L)/T8K(L)/T10K(L) HV Rear Panel

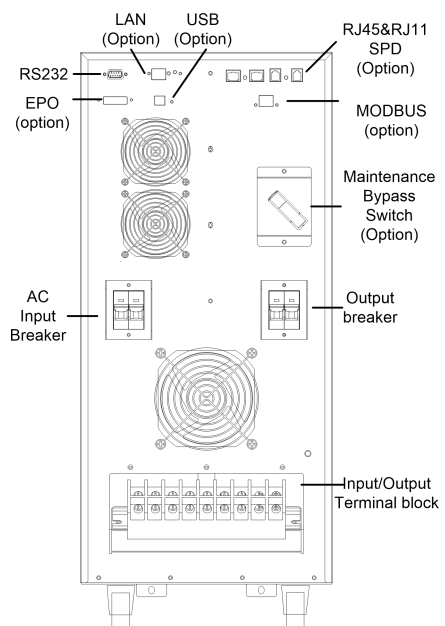

T6K(L)/T8K(L)/1T0K(L) LV (Dual Phase)Rear Panel

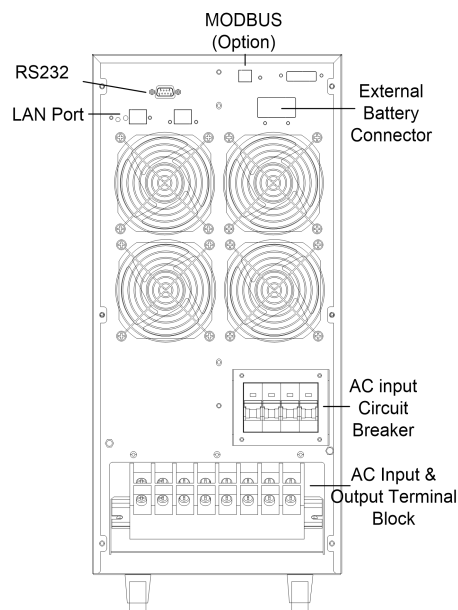

T15K(L)/T20K(L)Rear Panel



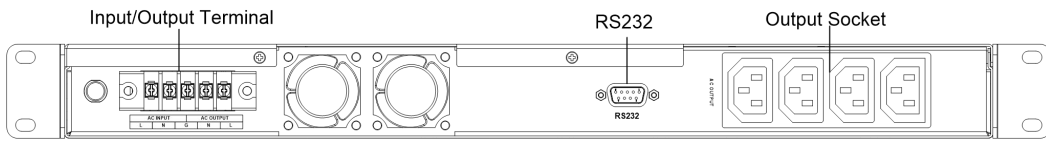

T1KR-1U RACK UPS Rear Panel



T1KR(L)-1U RACK UPS Rear Panel

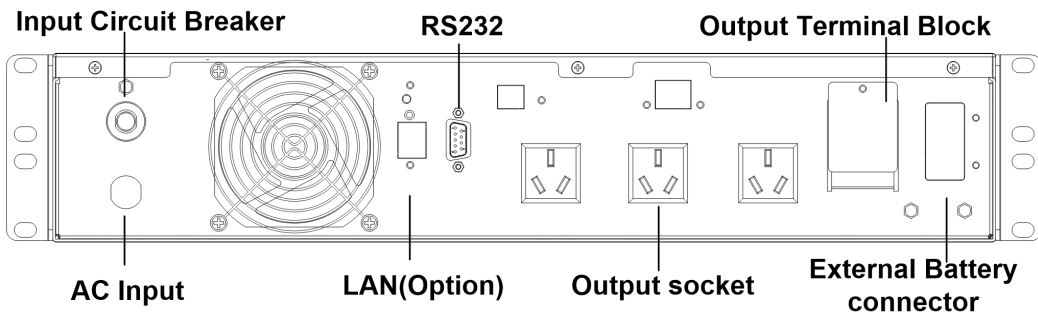

T1/T2KR(L) RACK UPS Rear Panel

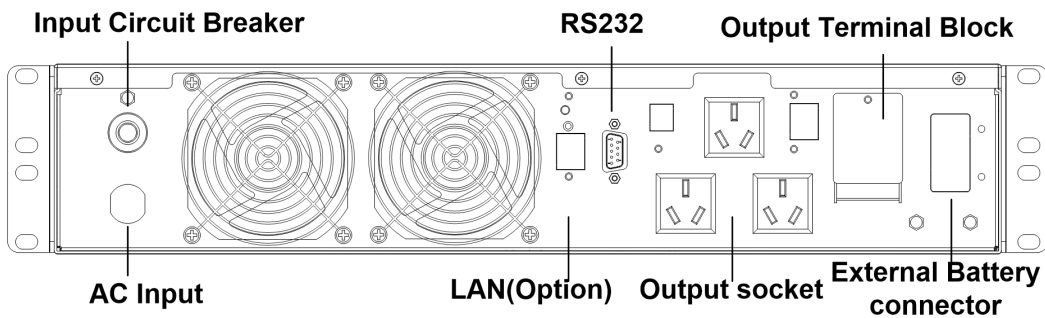

T3KR(L) RACK UPS Rear Panel

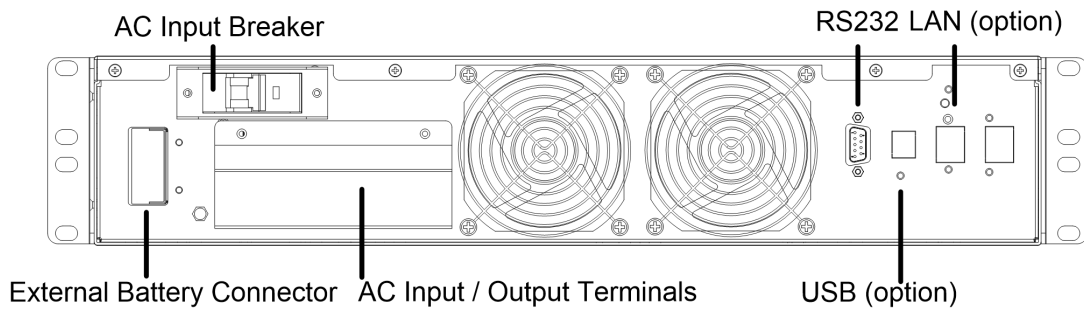

T6/10KR(L) RACK UPS Rear Panel

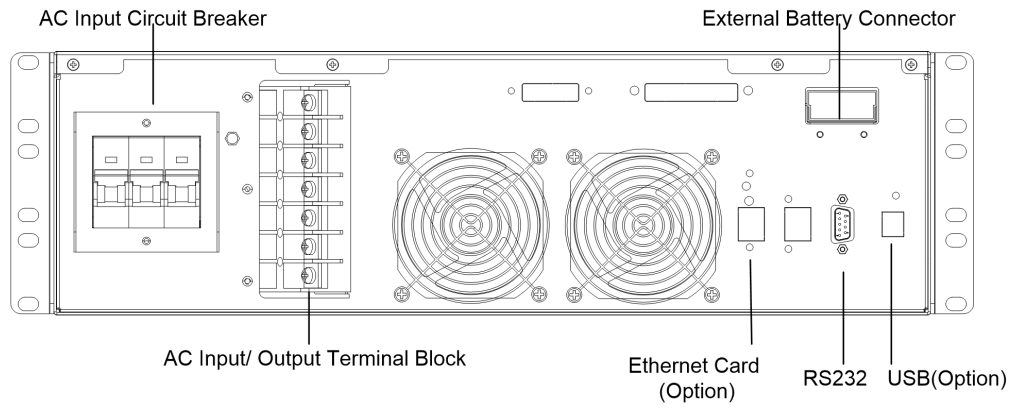

T10KRL-3P1 Rack UPS Rear Panel

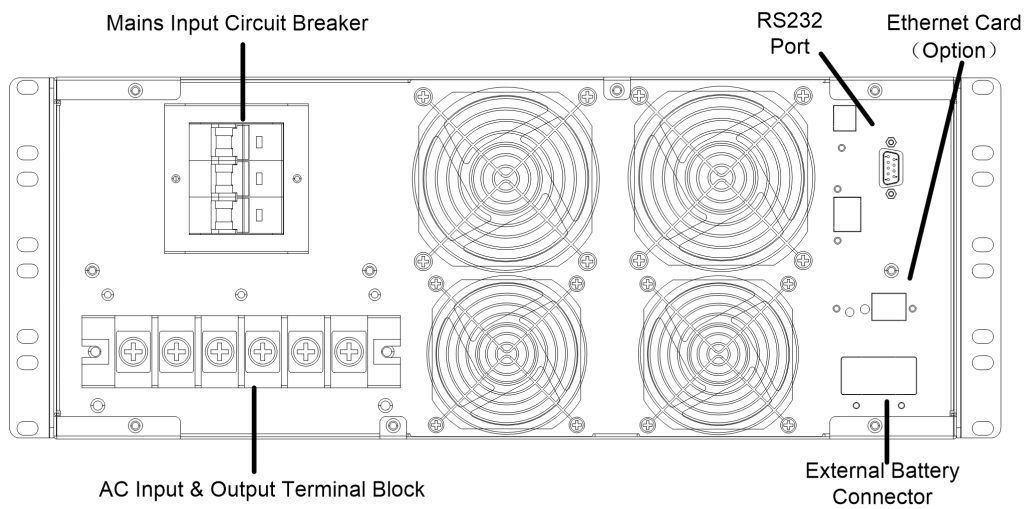

T15/T20KRL-3P1 Rack UPS Rear Panel

Note:

1. The socket and terminal configuration on the rear panel may be slightly different for countries or regions according to order.
2. External battery connectors available only for long backup type UPS.

# Chapter 3 Installation

## 3.1 Product inspection

- Unpacking the cabinet, Open the outer carton and remove the accessories Packed in the cabinet.
  - Carefully lift the cabinet out of the outer carton. Note the UPS mode with internal battery is heavy, two person or proper tools should be used to take the equipment out.
  - Inspection equipment
    - Check the product appearance, display, terminal block, socket, connector, NO contamination and deformation should be found.
    - Checking accessories according to below of shipping list.
- Please contact the distributor if damages or lack of accessories are found.

UPS accessories of shipping list:

Model	Accessory	Quantity	Unit
Standard Model (1-20K)	User manual	1	PCS
Long Backup Time Model (1-20KL)	User manual	1	PCS
	External battery cable	1	PCS

## 3.2 Installation

Because of heavy weight, a steady space needed to install the UPS. Cool, good ventilation, less humidity and dust are required for safe and reliable operation of the UPS.

## 3.3 Wiring

### NOTE:

Do not apply power to the UPS until installation is totally completed.

Do not make unauthorized changes to the UPS; otherwise, damage may occur to your equipment and void your warranty.

### 3.3.1 Input Wiring

T1, T2, T3K HV(220V/230V/240V) Model comes with input cable with plug. Plug the input cable to appropriate mains supply socket.

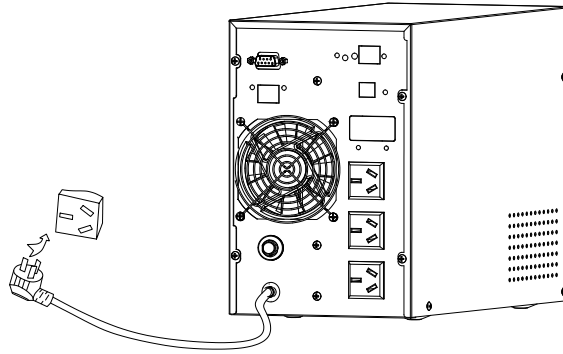

T1, T2, T3K LV(110V/120V/127V) Model and T6K, T10K, T6K(LV), T10K(LV) model use fixed terminal block for input wiring, a ring terminal is recommended for reliable wiring.

Note the voltage and current rating of the product. Refer to below table for input wiring

Model	Nominal Input Voltage	Rated Input Current	Input Cable AWG/Cross-section Area
T1K(HV)	220V/230V/240V	5.5A	14AWG/2mm <sup>2</sup>
T2K(HV)	220V/230V/240V	11A	14AWG/2mm <sup>2</sup>
T3K(HV)	220V/230V/240V	16A	14AWG/2mm <sup>2</sup>
T1K(LV)	110V/120V/127V	10A	14AWG/2mm <sup>2</sup>
T2K(LV)	110V/120V/127V	22A	12AWG/4mm <sup>2</sup>
T3K(LV)	110V/120V/127V	32A	10AWG/6mm <sup>2</sup>
T6K	220V/230V/240V	32A	10AWG/6mm <sup>2</sup>
T10K	220V/230V/240V	55A	8AWG/8mm <sup>2</sup>
T6K(LV)	220V/230V/240V (Dual phase Input, L1-L2)	32A	10AWG/6mm <sup>2</sup>
T10K(LV)		55A	8AWG/8mm <sup>2</sup>
T15KVA	220V/230V/240V	69A	1Phase I/P 7AWG / 10mm <sup>2</sup> 3phase I/P 10AWG / 6mm <sup>2</sup>
T20KVA	220V/230V/240V	91A	1Phase I/P 6AWG / 12mm <sup>2</sup> 3phase I/P 10AWG / 6mm <sup>2</sup>

Even internal over current protection breaker is embedded in the product, external switchable circuit breaker should be installed at upstream of the UPS product for safe installation and maintenance of product.

### 3.3.2 Output Wiring

The input of the equipment needs to be protected by UPS should connect to the UPS output

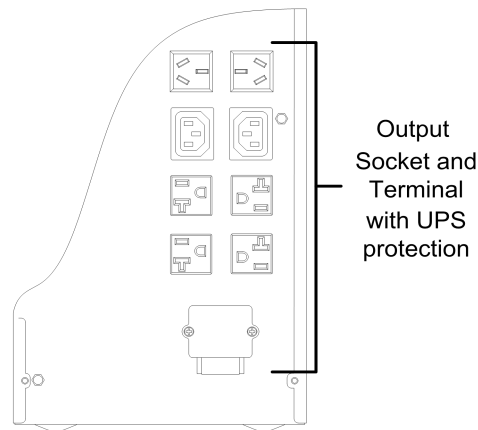

T1~T3K output socket and terminal

6~20kVA model input and output wiring connector is a ring type terminal block, the wiring should well make with suitable ring type terminal, to make sure the wire is securely fix to the terminal block, loosen or other kind of bad connection make cause over head or even fire accident, which much avoid

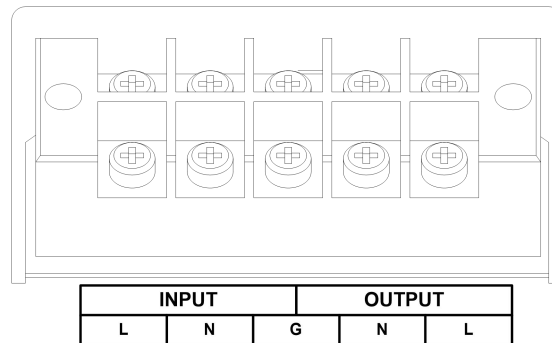

T6K/T10K Input and output terminal arrangement

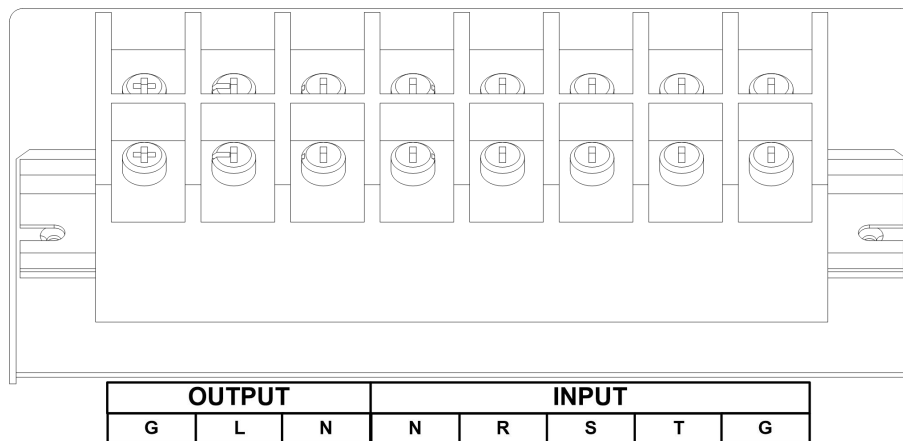

T15K/T20K Input and output terminal arrangement

T15K, T20K model can Work with 1phase and 3 phase mains input, however, no matter single

phase or 3phases mains are used, the R Phase wiring should choose big enough cable to carry full rated current of 69A/91A considering bypass operating situation.

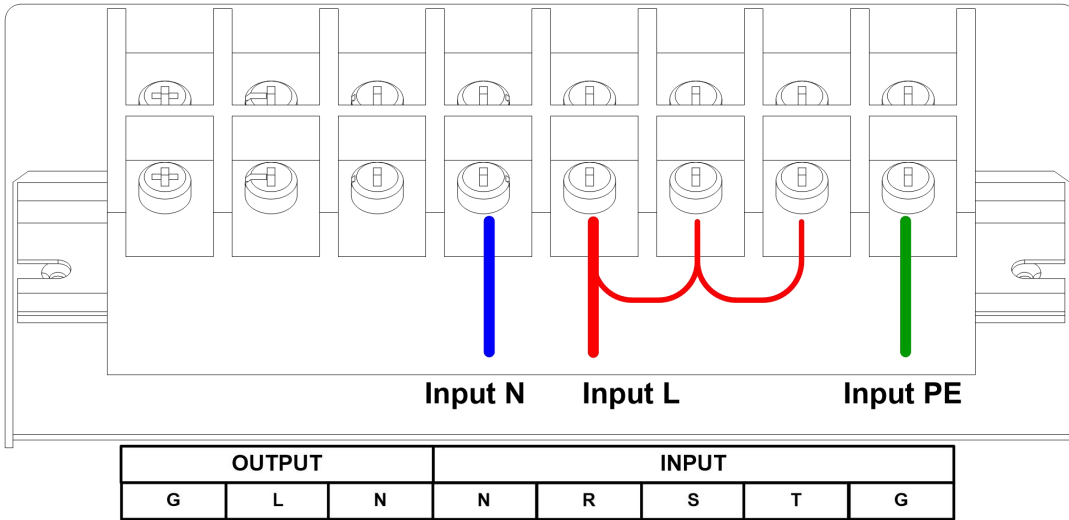

T15K, T20K 1phase input wiring

For T15K, T20K model, to work with single phase mains input, just short-circuit input R,S,T terminal and connect 1phase 3wire( L, N, G) to the input terminal as shown in above figure, the UPS will automatically work in single phase input mode.

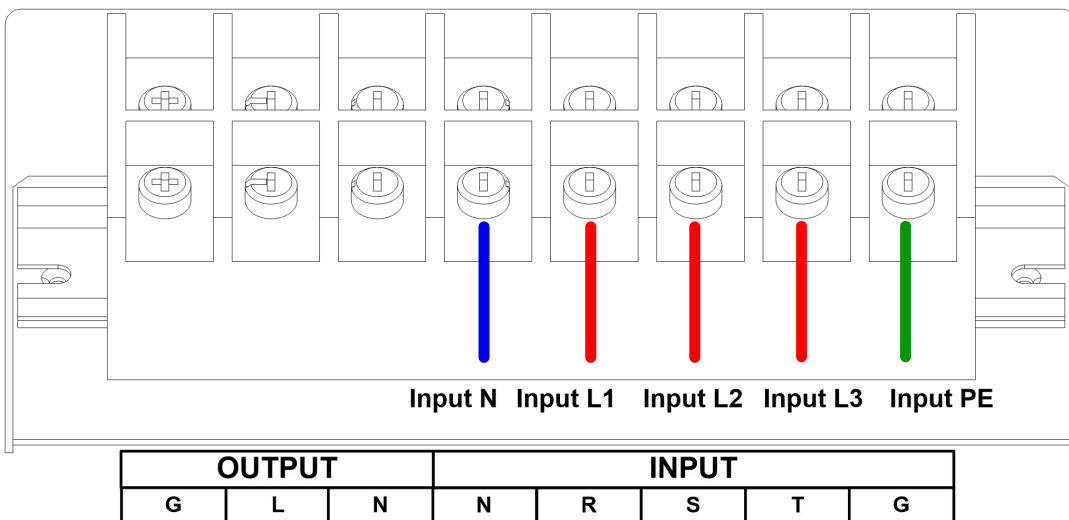

T15K, T20K 3phase input wiring

T6K(LV), T10K(LV) output is dual phase, can be configure to dual phase 120V+120V, or single phase 220V, as well as single phase 240V. Refer to below wiring guide:

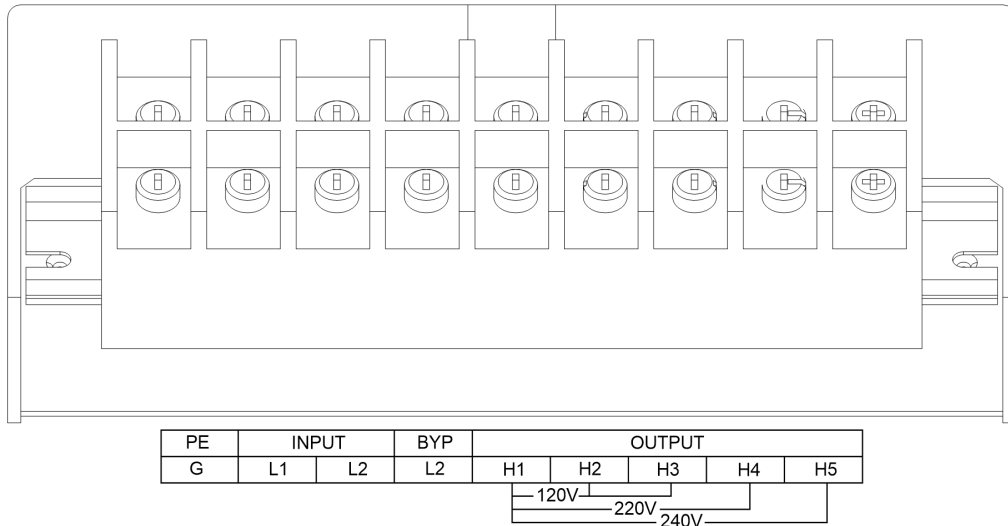

T6K, T10K\_LV Input and output terminal block with silkscreen marking

The T6K, T10K\_LV need 220/230V Nominal input voltage, typical Line L1, L2 of dual phase 110/120V Low voltage Mains system if suitable. The (optional) maintenance bypass (BYP) is default connected to L2 via a jumper, while user may select other source if only the voltage is 220/230V respect to L1.

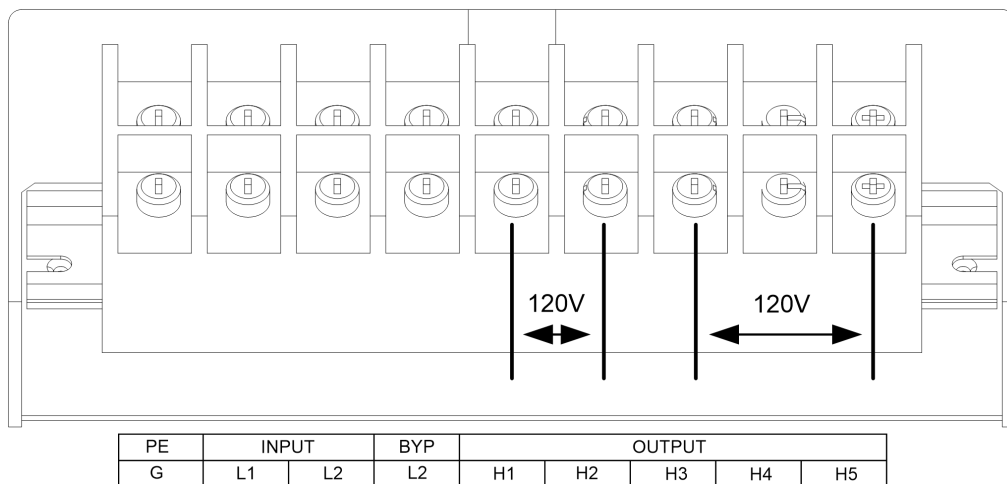

Dual Phase 120V Mode Wiring

To have Dual 120V output, remove the Jumper between terminal H2, H3. Then you can have Dual independent phase between H1&H2, H3&H5. because of galvanic isolation inside the UPS, In this case the H1, H3 act as neutral, and can be grounded to achieve zero ground-neutral voltage.

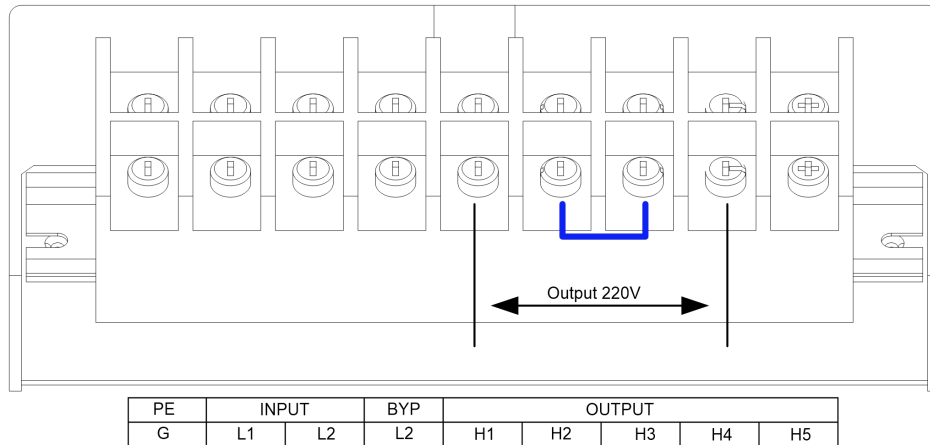

Single Phase 220V Mode Wiring

To have single 220V output, connect the Jumper between terminal H2, H3(default status). Then you can have Dual independent phase between H1& H4.

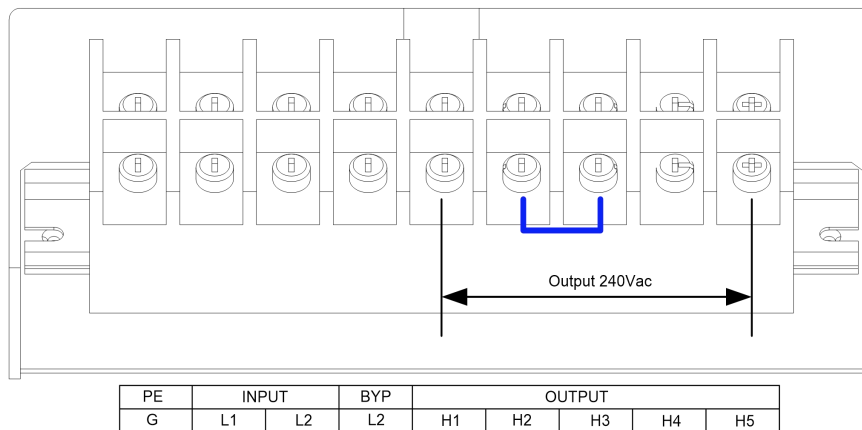

Single Phase 240V

To have single 240V output, connect the Jumper between terminal H2, H3(default status). Then you can have Dual independent phase between H1& H5.

Output socket and terminal block are available for output connection from UPS, with refer to figure in section 2.3.2:

Mode	Rating Capacity	Quantity of output socket	Output terminal block
T1K / 1KL	1kVA	6	NA
T2K / 2KL	2kVA	6	NA
T3K / 3KL	3kVA	8	Available
T6K / 6KL	6kVA	NA	Available
T10 / 10L	10kVA	NA	Available
T15K / 15KL	15kVA	NA	Available
T20K / 20KL	20kVA	NA	Available



Please find rated output capacity of product, avoid overload and used wire with sufficient current rating, with refer to below table.

Model	Nominal Output Voltage	Rated output Current	Wire for terminal
T1K(HV)	220V/230V/240V	5A	>14AWG/2mm <sup>2</sup>
T2K(HV)	220V/230V/240V	10A	>14AWG/2mm <sup>2</sup>
T3K(HV)	220V/230V/240V	15A	>14AWG/2mm <sup>2</sup>
T1K(LV)	110V/120V/127V	10A	>14AWG/2mm <sup>2</sup>
T2K(LV)	110V/120V/127V	20A	>12AWG/4mm <sup>2</sup>
T3K(LV)	110V/120V/127V	30A	>10AWG/5mm <sup>2</sup>
T6K	220V/230V/240V	30A	>10AWG/5mm <sup>2</sup>
T10K	220V/230V/240V	46A	>8AWG/8mm <sup>2</sup>
T6K(LV)	110V/120V/127V (Dual Phase Output)	30A+30A	10AWG/5mm <sup>2</sup> (Each phase)
T10K(LV)		46A+46A	8AWG/8mm <sup>2</sup> (Each phase)
T15KVA	220V/230V/240V	69A	>7AWG / 10mm <sup>2</sup>
T20KVA	220V/230V/240V	91A	>6AWG / 12mm <sup>2</sup>

Procedure for output wiring:

1. Plug the AC input cord of the equipment needs UPS protection to the output socket of the UPS.
2. To connect more equipment than available output socket number, please use extension cord, connect to the output socket or output terminal block, mind the total consumption current must not exceed rated current capacity of the product.
3. The output terminal is protected by a cover, uncover the terminal, use appropriate connecting terminal, prepare well the wire.
4. Fix the prepared wired to the terminal block, find the silkscreen marking for polarity of the wiring.

### 3.3.3 External Battery Cable

Connection of external battery is ABSOLUTELY CRITICAL. Any mistake may result in serious injure of electric shock or fire, damage of product: below steps must be strictly followed:

- The external battery bank must have a cut-off device, like circuit breaker or switch with fuses.
- TURN OFF the cut-off device, make sure no harmful voltage can be touched on the connector.

- Use only battery bank of correct voltage, check the product rating label for correct information.
- Choose Wire with sufficient current rated, prepared well the terminal.
- CHECK THE POLARITY of battery bank, fix wires of correct polarity to the battery bank with proper color and clear label for distinguish the polarity.
- Securely Plug / Fix the other end of the cable to UPS.
- Check the polarity of the wiring and fastness of the connection.
- Powered the UPS by turning on the cutoff device device.

Model	Nominal Battery Voltage	Rated Battery Current	Connection Wire
T1KL (HV/LV)	36V	30A	>10AWG/5mm <sup>2</sup>
T2KL (HV/LV)	72V	30A	>10AWG/5mm <sup>2</sup>
T3KL (HV/LV)	96V	30A	>10AWG/5mm <sup>2</sup>
T6KL	192V	40A	>10AWG/5mm <sup>2</sup>
T10KL-192B	192V	60A	> 8AWG/8mm <sup>2</sup>
T10KL-240B	240V	50A	
T20KL-16B	192V	110A	> 6AWG/12mm <sup>2</sup>
T20KL-20B	240V	100A	

### 3.3.4 Communication Cable (optional)

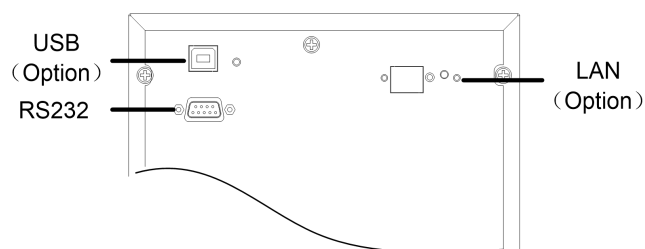

RS232: Connect UPS computer Interface (RS232) and monitor equipment through communication cable. consult with distributor for communication protocol.

Optional LAN port: support monitor the UPS via smart phone APP, PC software, Web-page Browser etc.

The Product also provide optional USB Port, Modbus Port, Relay Dry contact card, refer to optional port user manual for application .

# Chapter 4 Panel & Operation Guide

## 4.1 Front panel

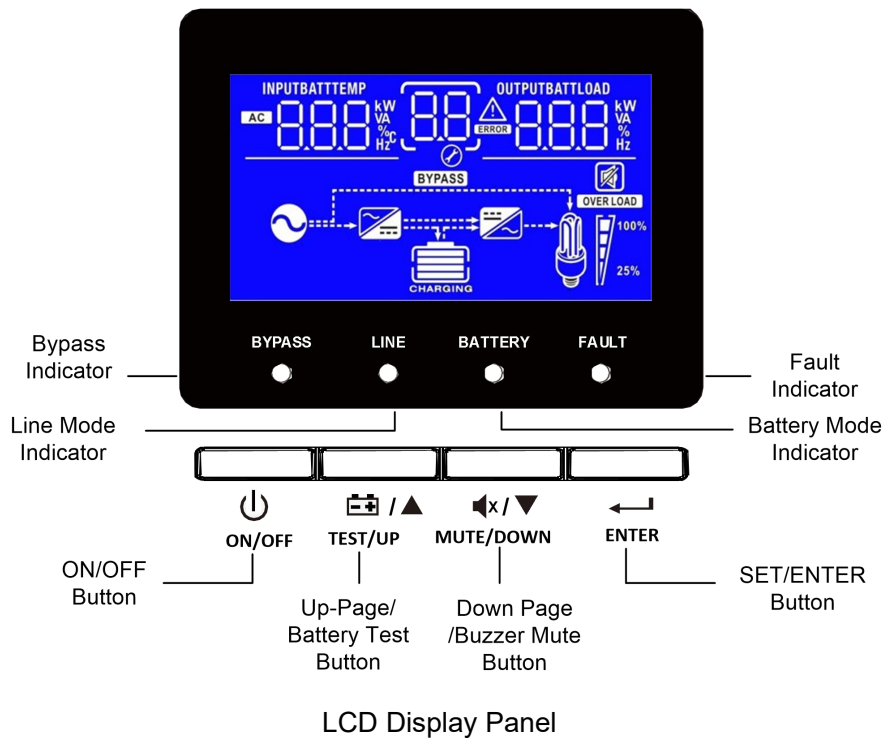

### 4.1.1 ON/OFF Button

ON/OFF Button is used to turn on/off the UPS.

### 4.1.2 Setting Enter button

Enter button is used to enter setting mode and confirm change of the setting.

### 4.1.3 Up Page/ Battery Self-test Button







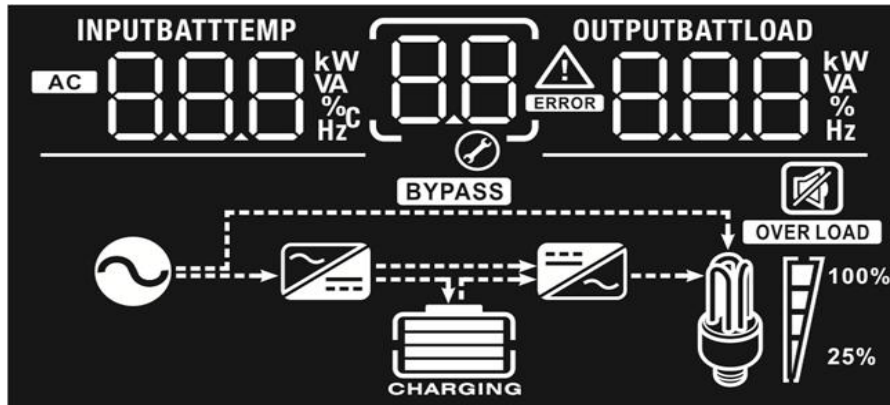

The Up page Button is used to switch the display the LCD display information, and activate the battery self-test function.









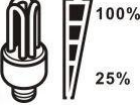

### 4.1.4 Down Page/Buzzer Muting function

The Down Page Button can also used to switch the display the LCD display information, and muted/recover the buzzer alarm function.

#### 4.1.5 LCD Display



con	Function description
<b>Input Source Information</b>	
	Indicates the AC input.
	Indicate input voltage, input frequency, battery voltage
<b>Fault Information</b>	
	Indicates the warning and fault codes. Warning:  flashing with warning code.
	Fault:  lighting with fault code
<b>Output Information</b>	
	Indicate output voltage, output frequency, load percent, load in VA, load in Watt.
<b>Battery Information</b>	
	Indicates battery level by 0-24%, 25-49%, 50-74% and 75-100% in battery mode and charging status in line mode.

Load Information				
	Indicates overload.			
	Indicates the load level by 0-25%, 26-50%, 51-75% and 76-100%.			
	0%~25%	26%~50%	51%~75%	76%~100%
				
Mode Operation Information				
	Indicates unit connects to the mains.			
	Indicates load is supplied by utility power.			
	Indicates the AC/DC PFC Rectifier and utility charger circuit is working.			
	Indicates the DC/AC Inverter circuit is working.			
Mute Operation				
	Indicates buzzer alarm is muted			

## 4.2 UPS Working Mode

### 4.2.1 Normal mode

Turn on the UPS, if the mains supply is normal, UPS will work in Normal mode (Line mode) and converse and filter the mains input for clean and stable AC output. The indicators display will show the operating mode.

If loading level is over 100% rated capacity, the buzzer beeps to remind you overloaded that you must reduce unnecessary load until the UPS loading level is less than 100%.

If the battery indicator blinks cyclically, it shows the UPS disconnect from battery or the battery condition is abnormal. Please check the battery connection and battery condition for prevent UPS output unexpected interruption upon mains supply power losses.

### 4.2.2 Battery mode

When mains utility power is abnormal condition, such as blackout or fluctuation in voltage, frequency as

well as waveform, UPS will automatically switch to run in battery mode, in which the battery work as energy source, and maintain the stable AC power supply at the output side of the UPS product.

In the Battery mode, UPS will beep once every 4s. the user can mute the buzzer beep by the down page(mute) button.

If the battery capacity is very low, the UPS will beep once every 1S. It is alarm to take off the load as soon as possible.

Backup function can be tested through battery self test via Up Page (battery test) button.

### **4.2.3 Bypass mode**

The ups work on bypass mode when the UPS start up or abnormal situation occurs to the converters and can not work properly. The mains power is fed to the load through the bypass circuit in such mode without protection. Please note that when UPS running in bypass mode, UPS has no backup function either, because load power is supplied by the utility power directly.

## **4.3 Operation**

### **4.3.1 Turn on UPS**

#### **Turning on with utility power**

Connect the mains input to the UPS, press and hold the ON/OFF button for more than 3 seconds until the buzzer beeps. the UPS begins to conduct self-test, seconds later, utility power icon and the Inverter icon shown and the UPS begins to output supply and operate under the Normal mode. If the utility power is abnormal, the UPS will work under the Battery mode.

#### **Turning on without utility power**

With no mains input to feed the UPS, press and hold the ON/OFF for than 3 seconds, the UPS response with a buzzer beep. In the turn on process, the UPS has the same operation as if it is connected to utility power that the utility power icon will not shown, instead the battery icon shown.

### **4.3.2 Turn off UPS**

The operation of powering down contains: Power down under Normal mode and Battery mode

### **Turn off UPS under the Normal mode**

Press and hold the ON/OFF button for more than 3 second to turn off UPS. If bypass mode is enable, the bypass indicator will be turned on to indicate that UPS is working in bypass mode. In order to cut off the output of the UPS, simply cut off the utility power. Finally, not any display is shown on the front panel and no output is available from the UPS outlets.

### **Turn off UPS under the Battery mode**

Press and hold the “ON/OFF” for 3second to turn off the UPS. The UPS cut off UPS output supply, and the UPS totally turn off after approximately 1minute.

### **4.3.3 Enter Setting Mode**

When UPS Work on Bypass or Standby Mode, Press the Setting Enter Button for 5 seconds, the UPS enter setting mode, accept setting of output voltage, frequency, battery number, bypass enable/disable, ECO mode enable /disable, EPO function ON/OFF.

Use Up page and down Page to change the setting . and short press the setting for confirm the change

After setting, turn off the mains power supply, wait the UPS turn off under battery mode until display if total off, turn on the UPS again to activate the setting change.

### **4.3.4 Battery Self-test**

In Normal mode, press the Up Page Button for more than 4 seconds until the buzzer beeps. he UPS switch to battery test mode, to check the status of the battery, the UPS exit the battery test mode if the battery abnormal and present alarm with the battery icon flashing. If test mode end up with normal, the UPS switch to normal mode automatically.

### **4.3.5 Buzzer Mute**

When UPS is on battery or bypass mode, UPS will warn with warning tone (Battery mode four seconds one tone; Bypass mode two minutes. You can disable or enable the buzzer tone manually.

In the battery and bypass mode, push Down Page button for about 4 seconds until you here a buzzer beep. the buzzer alarm can be muted. Press the button for 4seconds again to recover the buzzer alarm function.

The Buzzer Muting is valid only in battery mode, and invalid for any other UPS alarm.

# Chapter 5 Maintenance

---

## 5.1 Routine Maintain

To make sure UPS work normal, appropriate maintenance should be schedule periodical, below items should be checked:

### **Check UPS running status.**

If the utility power is normal, UPS should work in line mode or in battery mode. And there is no warning or fault indication.

### **Check UPS running mode switch.**

Cut off the line input to simulate the utility power interrupt, UPS should transfer to battery mode, and connect the line input, UPS return to line mode again.

### **Check UPS panel.**

Check UPS panel display if it is consistent with UPS running mode.

## 5.2 Battery Maintain

Typical life span of a lead acid battery is 300 cycle or 2~3years in an environment of 15-25°C ambient temperature.

Battery is a very important part in the UPS system. The life of battery affected by the environment temperature and cycling use times, high temperature and deep discharge will decrease the battery life.

Battery test can find out battery most problem in battery. for external battery bank, voltage of each battery unit can be a indicator for the battery health status, under not charged condition, battery voltage of in bad unit condition will drop quickly, or significantly stray from that of the rest unit in the same battery bank. Professional battery check is to test battery with battery diagnostic instrument, in which battery impedance is measure,

If UPS is not used, it is suggested to charge the battery once every 6 months.

Normally, the battery should be discharged once every 4 to 6 months.

The battery replacement should be done by qualified technician, please get the advice from local distributor.



# Chapter 6 Trouble shooting

When any trouble with UPS, please check the problem refer to the table below first. If the problem cannot be solved, please contact local supplier.

## 6.1 LCD Warning and Fault Code

Fault code	Description	Possible cause and solution
01	UPS start up not success	Battery Low
		UPS Internal failure, Contact distributor for service
02	Internal DC BUS over-voltage protection	Half-wave rectifier load(hair dryer, half-wave solenoid valve , energy re-generated type load (motor, huge transformer, capacitor with residue charge, remove this kind of load and turn on the UPS again.
		Over mains voltage, turn on the UPS again.
		UPS Internal failure, Contact distributor for service
03	Internal DC BUS under-voltage protection	Battery Low or overload
		UPS Internal failure, Contact distributor for service
10	UPS Output Short-Circuit	Remove short-circuit equipment from UPS
22	UPS Over Load	Reduce loading capacity below UPS rating
23	UPS Over Temperature	Make sure UPS should work in ambient of -10-45°C, if the ambient temperature can't meet this spec. Try reduce loading
		Check ventilation inlet of the UPS ON from panel and outlet on the rear panel is not blocked
		UPS Internal failure, Contact distributor for service
29	UPS Input rectifier protection	Low input voltage and overload
		UPS Internal failure, Contact distributor for service
57	Battery UN-connected	Check battery input wiring and battery cutoff device such as circuit breaker etc.
59	Charger Fail	UPS Internal failure, Contact distributor for service
60	EPO activated	Reset the External EPO switch, if no EPO switch install, turn off EPO function via the operating panel
	Battery Icon Flashing	Battery not connected or battery low
		Charger failure, Contact distributor for service
UPS not working normal line mode, With normal mains input		Make sure Input circuit breaker is ON
		Turn on the UPS via ON/OFF button
Backup time is not as long as expected		Battery low, recharge the battery long enough time
		Overload, reduce the loading
		Battery aged, Contact distributor for service
UPS not turn ON after pressing ON/OFF button		Press the ON/OFF button long enough time, 3seconds, and hear a buzzer beep for acknowledging the correct TURN ON operation
		Battery low or not connected
		UPS Internal failure, Contact distributor for service

# Chapter 7 Specification

## 7.1 1 phase input model Specification

Model item		T1K(R)	T1K(R)L	T2K (R)	T2K (R)L	T3K (R)	T3K(R)L	T6K	T6K(R)L	T10K	T10K(R)L	
Rated power		1000VA/900W		2000VA/1800W		3000VA/2700W		6kVA/5.4kW		10kVA/9kW		
AC Input	Input system	Single phase (L/N+PE)										
	Nominal voltage	HV: 208/220/230/240Vac LV:100/110/120/127Vac										
	Frequency	50/60Hz										
	Voltage range	HV: 90~300VAC±5VAC LV: 60-145Vac±3VAC										
	Frequency range	(40~70)±0.5Hz										
	Input power factor	>0.99										
	Bypass Voltage Range	HV: 115~285VAC×(1±3%) LV: 80~140VAC×(1±3%)										
Battery Input	Nominal Voltage	24V	36V	48V	72V	72V	96V	192V	192V	192V/240V		
	Battery Capacity & Quantity	12V/9AH x 2pcs	External	12V/9AH x 4pcs	External	12V/9AH x 6pcs	External	12V/9AH x 16pcs	External	12V/9AH x16/20pcs	External	
	Backup Time	Half loaded≥8minutes, Full loaded ≥3minutes(standard)						Half loaded≥6minutes, Full loaded ≥3minutes(standard)				
	Battery charger time	Charger to 90% battery capacity in 5 hours(standard) Dependent on the capacity of external batteries (long backup time)										
AC Output	Output wiring system	Single phase (L/N+PE)										
	Inverter Mode	HV:208/220/230/240Vac±2%										
	Output voltage	LV: 100/110/120/127Vac±2%										
	Waveform	Sine Wave										
	Harmonic Distortion	THD<2% (linear load) THD<7% (nonlinear load)										
	Output frequency	50/60±4Hz (Sync mode) 50/60Hz±1% (Fix Freq. mode)										
	Overload capability	105 ~ 125%≥ 60s, 126 ~ 150%≥30s The recover point is 70%										
Efficiency	Transfer time	Battery <-> Line Mode :0ms										
	Line Mode	HV:86% LV:86%		HV:88% LV:86%		HV:89% LV:87%		HV:92% LV:88%		HV:93% LV:89%		
	Battery Mode	HV&LV:85%		HV&LV:86%		HV&LV:87%						
Communications		RS232 RS485(optional), Dry contact(optional), Network Card(Option)										
Alarm Function		AC/DC input under abnormal, overload condition and Inverter problems										
Protection Function		AC input or output above or below the range of voltage, overload, over temperature and short circuit protection										
Noise		<50dB						<55dB				

1. Subject to change according to order, check the product name plate for specified battery voltage information.

## 7.2 3phases input model Specification

Item Model	T10K-3P1	T10KL-3P1	T15K-3P1	T15KL-3P1	T20K-3P1	T20KL-3P1	
Rated power	10KVA/9KW		15KVA/13.5KW		20KVA/18KW		
AC Input	Input system						3phases (L1, L2, L3, N, PE) or 1phases (L, N, PE)
	Nominal voltage						208/220/230/240Vac
	Frequency						50Hz/60HZ
	Voltage range						L-N : 90~300VAC±5VAC L-L: 156~520VAC ±5VAC
	Frequency range						(40~70)±0.5Hz
	Input power factor						>0.99
	Bypass Voltage Range						115~285VAC×(1±3%)
Battery Input	Nominal Voltage						192V/240V (Selectable)
	Battery Capacity & Quantity	12V/7AH x 16pcs	External	12V/7AH x 32pcs	External	12V/7AH x 32pcs	External
	Backup Time	Standard Model with internal battery: half load ≥6min, full load ≥ 1.5min Long backup time Model: determined by external battery					
	Battery charger Time	Standard Model with internal battery : 5 hours to 90% Long backup time Model: determined by external battery					
AC Output	Output wiring system						1 phase 3 wire (L ,N, G)
	Inverter Mode Output voltage						220/230/240Vac±2%
	Waveform						Sine wave
	Output frequency						50/60±4Hz (Sync mode) 50/60Hz±1% (Fix Freq. mode)
	Harmonic Distortion						THD <2% (Linear Load) THD <7% (non-linear Load)
	Overload capability						Line mode / Battery Mode with 240VDC 105~125% 10mins, 126~150% 1min , >150% 100ms Battery Mode with 192VDC 105~125% 1s, >126% 100ms
	Transfer time						Line mode <-> Battery Mode 0ms
Efficiency	Line Mode		93%		94%		
	Battery Mode		92%		93%		
Communications Port						RS232 RS485(optional), Dry contact(optional), Network Card(Option)	
Noise						<50dB	<55dB
Protection Function						AC input or output above or below the range of voltage, overload, over temperature and short circuit protection	

### 7.3 Mechanical

Model	W x H x L(mm)	Weight(kg)	Remark
T1KL	145×220×248	3.5	Compact size version
T1K	145×220×318	8.9	Internal 2Pcs Battery
T2K	145×220×390	14.0	Internal 4Pcs Battery
T2KL	145×220×318	5.9	
T3K	190×318×368	21.6	Internal 6Pcs Battery
T3KL	190×318×368	8.3	
T1KRL-1U	438x44(1U)×360	7.9	1U RACK
T1KR	438x87(2U)×360	13.0	Internal 2pcs*12V/7AH Battery
T1KRL	438x87(2U)×360	8.5	
T2KR	438x87(2U)×360	18.5	Internal 4pcs*12V/7AH Battery
T2KRL	438x87(2U)×360	11.5	
T3KRL	438x87(2U)×360	12	
T3KR-4B	438x87(2U)×500	21.9	Internal 4pcs*12V/9AH Battery
T6K-12B	190x360x528	37	Internal 12Pcs Battery
T6K-16B	190x470x534	46.5	Internal 16Pcs Battery
T6KL	190×318×368	10.0	
T10KL	190x340x528	16.0	
T10K-16B	190x470x534	47.5	Internal 16Pcs Battery
T6KRL	438x87(2U)x500	14.6	
T10KRL	438x87(2U)x500	15.0	
T10KRL-3P1	438x132(3U)x530	19.5	3-1 / 1-1 COMBO
T15KRL-3P1	438x176(4U)x530	25.0	
T20KRL-3P1	438x176(4U)x530	26.0	
T10KL-3P1	190x340x528	17.0	
T15KL-3P1	238x528x550	25.6	
T20KL-3P1		26.1	
T6KL-DP-A	296x720x700	100	Dual Phase output (120/240V) Product with internal battery
T10KL-DP-A		102	
T15KL-3P1-DP		106	
T20KL-3P1-DP		109	
T6K-DP-A		132	
T10K-DP-A		142	
TK EBM0607	440x87(2U)x360	15.5	2KVA Battery Pack
TK EBM0807	440x87(2U)x360	20.5	3KVA Battery Pack
TK EBM1607B	438x132(3U)x500	39	16pcs 7AH 3U Battery Pack

## 7.4 Environmental

ITEM	Normal range
Ambient temperature	-10°C~ +40°C
Environment humidity	0~97%, no condensing
Altitude	no derating for lower than 1000M: Over 1000m :1% derating for every 100M rise
Storage temperature	-15°C~+45°C

## 7.5 EMC & Safety Regulation

ITEM	Standard	Level
ESD	IEC61000-4-2	LEVEL4
RS	IEC61000-4-3	LEVEL3
EFT	IEC61000-4-4	LEVEL4
SURGE	IEC61000-4-5	LEVEL4
Safety	IEC62040-1	

## Warranty

Products to be offered warranty from the date of purchase within the warranty period.

- Serial number of the product or sales contract is credentials to the warranty.
- In case of UPS fault, please contact local service center and dealer. The transportation charges shall be borne by the buyer.

As a user, any problem you have the following service:

- Online Service via email or website.
- Local distributor replace or repair service.

This limited warranty does not apply to conditions as follows:

- Damage or loss resulted from force majeure or external causes;
- Warranty period expired;
- The product serial number is missed or modified;
- Disassemble or modifications to the product without authorization;
- Man-made damage;